

ENABLING QOS PROVISIONING SUPPORT FOR DELAY-CRITICAL TRAFFIC AND MULTI-FLOW HANDLING IN NS-3 5G-LENA

KATERINA KOUTLIA

SANDRA LAGEN

BILJANA BOJOVIC

6G  BLUR

 **cttc**^R

Centre Tecnològic de
Telecomunicacions de Catalunya

AGENDA

- Introduction
- 5G NR QoS Model
- Proposed QoS MAC Scheduler
- QoS LC Assignment
- ns-3 Implementation
- ns-3 Implementation QoS MAC Scheduler
- ns-3 Implementation LC Assignment
- ns-3 Implementation Extensions
- Evaluation Approach
- Simulation Results

INTRODUCTION

- Mobile communication advances opened the way for various innovative traffic applications
 - Stringent latency and varying QoS requirements
 - Multi-Flow traffic
- Scheduling becomes challenging!

-  introduces the QoS Model

- This architecture enables the support of delay-critical and multi-flow traffic



5G NR QoS MODEL

- Control is moved to the QoS flow level
- Two-layer architecture:
 - CN: mapping of SDFs to QoS flows
 - M:1 multiple SDFs to 1 QoS flow
 - 1:1 each SDF to 1 QoS flow
 - RAN: mapping of QoS flows to DRBs
 - N:1 multiple QoS flows to 1 DRB
 - 1:1 each QoS flow to 1 DRB

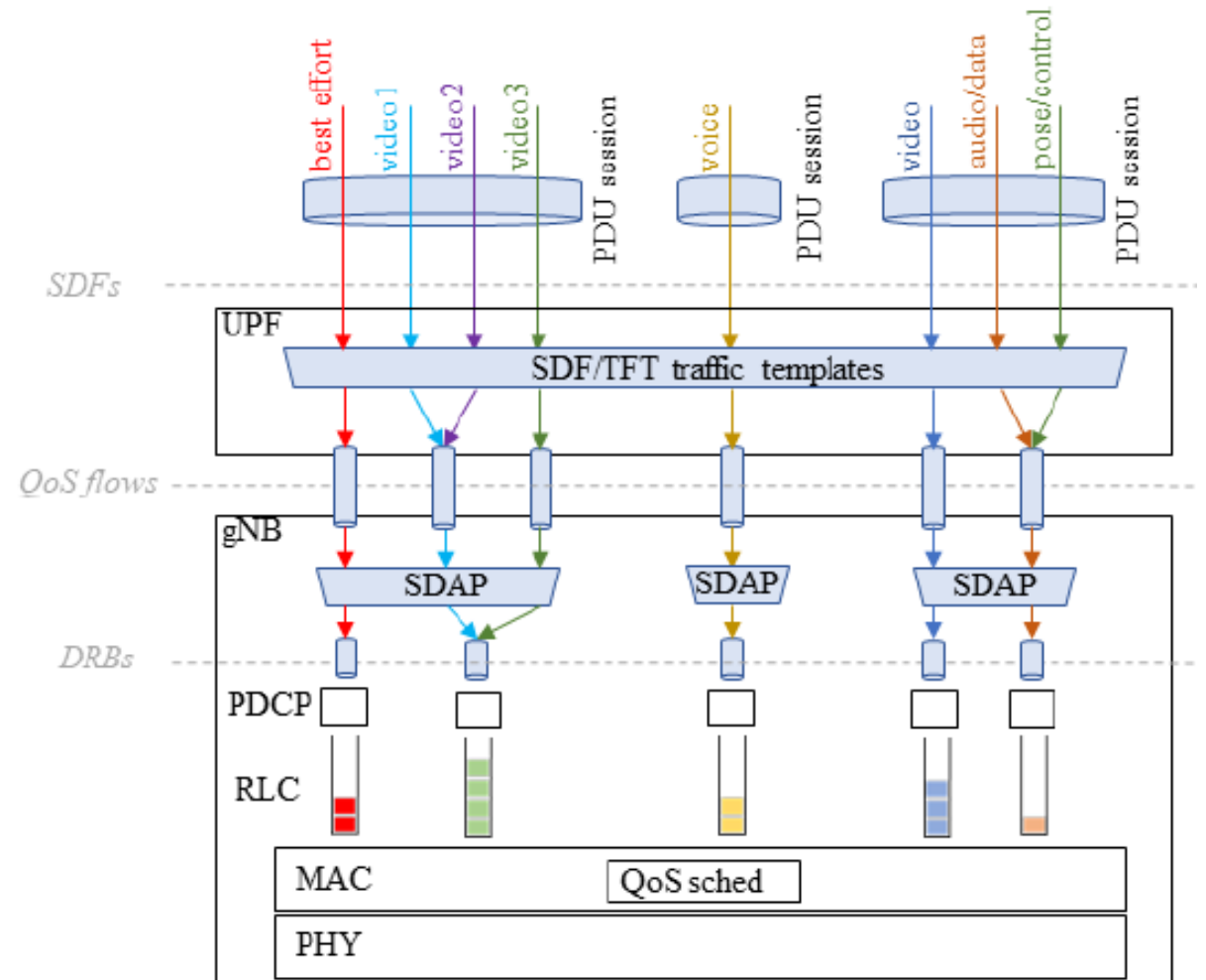

5G NR QoS MODEL

- A QoS flow is classified using a **QoS flow identifier (QFI)** in the network
- Included as an encapsulation header
- Indicates how a QoS flow should be treated
- 5QI includes the characteristics of the flow:
 - the resource type (GBR/non-GBR/DC-GBR)
 - the Priority Level (P)
 - the Packet Delay Budget (PDB)
 - the Packet Error Rate (PER)
 - the Averaging Window (for GBR/DC-GBR)
 - the Maximum Data Burst Volume (for DC-GBR)

5QI Value	Resource Type	Default Priority Level	Packet Delay Budget (NOTE 3)	Packet Error Rate	Default Maximum Data Burst Volume (NOTE 2)	Default Averaging Window	Example Services
1	GBR (NOTE 1)	20	100 ms (NOTE 11, NOTE 13)	10^{-2}	N/A	2000 ms	Conversational Voice
2		40	150 ms (NOTE 11, NOTE 13)	10^{-3}	N/A	2000 ms	Conversational Video (Live Streaming)
3		30	50 ms (NOTE 11, NOTE 13)	10^{-3}	N/A	2000 ms	Real Time Gaming, V2X messages (see TS 23.287 [121]); Electricity distribution – medium voltage, Process automation monitoring
...	
5	Non-GBR (NOTE 1)	10	100 ms NOTE 10, NOTE 13)	10^{-6}	N/A	N/A	IMS Signalling
6		60	300 ms (NOTE 10, NOTE 13)	10^{-6}	N/A	N/A	Video (Buffered Streaming) TCP-based (e.g., www, e-mail, chat, ftp, p2p file sharing, progressive video, etc.)
7		70	100 ms (NOTE 10, NOTE 13)	10^{-3}	N/A	N/A	Voice, Video (Live Streaming) Interactive Gaming
...	
82	Delay-critical GBR	19	10 ms (NOTE 4)	10^{-4}	255 bytes	2000 ms	Discrete Automation (see TS 22.261 [2])
83		22	10 ms (NOTE 4)	10^{-4}	1354 bytes (NOTE 3)	2000 ms	Discrete Automation (see TS 22.261 [2]); V2X messages (UE - RSU Platooning, Advanced Driving: Cooperative Lane Change with low LoA. See TS 22.186 [111], TS 23.287 [121])
84		24	30 ms (NOTE 6)	10^{-5}	1354 bytes (NOTE 3)	2000 ms	Intelligent transport systems (see TS 22.261 [2])
...	

PROPOSED QoS MAC SCHEDULER

- We propose a generalized QoS MAC scheduler based on scheduling weights
 - QoS Flow descriptors
 - Resource Type (non-GBR/GBR/DC-GBR)
 - Priority Level (P)
 - Packet Delay Budget (PDB)
 - Real-Time measurements in the MAC Layer
 - Head-Of-Line Delay (HOL)
 - Proportional Fair Metric

$$w = \begin{cases} (100 - P) \frac{r^\gamma}{R(\tau)} + F & \text{for non-GBR and GBR} \\ (100 - P) \frac{r^\gamma}{R(\tau)} D + F & \text{for DC-GBR} \end{cases}$$

- r is the instantaneous achievable data rate
- $R(\tau)$ is the past average data rate updated within the updated window size τ
- F is 100 for retransmission, and $F=10$ otherwise
- γ is a configurable parameter
- D is the newly introduced delay budget factor:

$$D = \frac{\text{PDB}}{\text{PDB} - \text{HOL}}$$

PROPOSED QOS MAC SCHEDULER

- The active UEs are then classified in descending order in each Transmission Time Interval (TTI) based on the sum of the calculated scheduling weights for all their active flows:

$$W = \sum_{n=1}^N w$$

- N is the number of active Logical Channels (LCs) for a given UE
- Advantages of the proposed solution:
 - Promotes flows with stringent latency requirements
 - Packet discards are avoided for these flows
 - Considers the P of a flow
 - Guarantees higher throughputs and use fairness (PF metric)

} D

QOS LC ASSIGNMENT

- To serve multi-flow traffic the LC assignment is also of high importance
- Assign bytes to LCs considering:
 - The guaranteed bit rate (*e_rabGuaranteedBitRate*)
 - The resource type of a flow
- The algorithm first finds the active GBR and DC-GBR with the *e_rabGuaranteedBitRate* set.
 - In case there are more than 1 and the total requirements exceed the assigned bytes -> Assign equally the assigned bytes (RR fashion)
 - In case their total requirements are less than the assigned bytes -> Assign the minimum among the *e_rabGuaranteedBitRate* and the RLC buffer size
- The rest of the bytes (if any), are assigned in RR fashion to the rest of LCs

QOS LC ASSIGNMENT

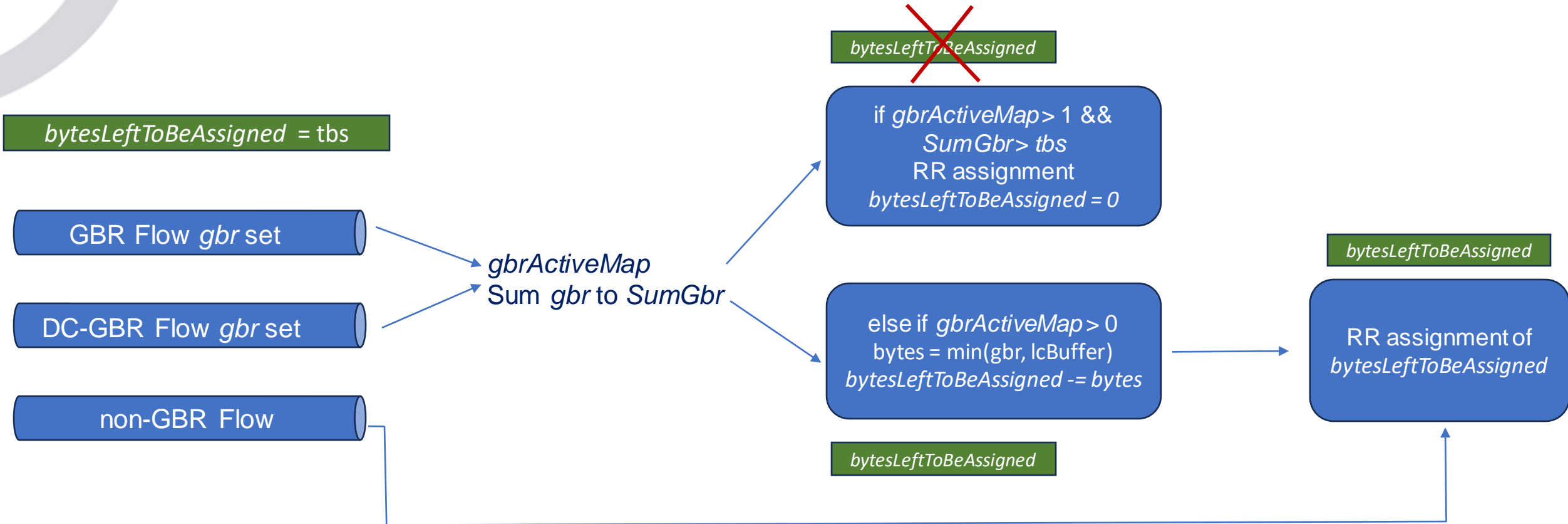

NS-3 IMPLEMENTATION

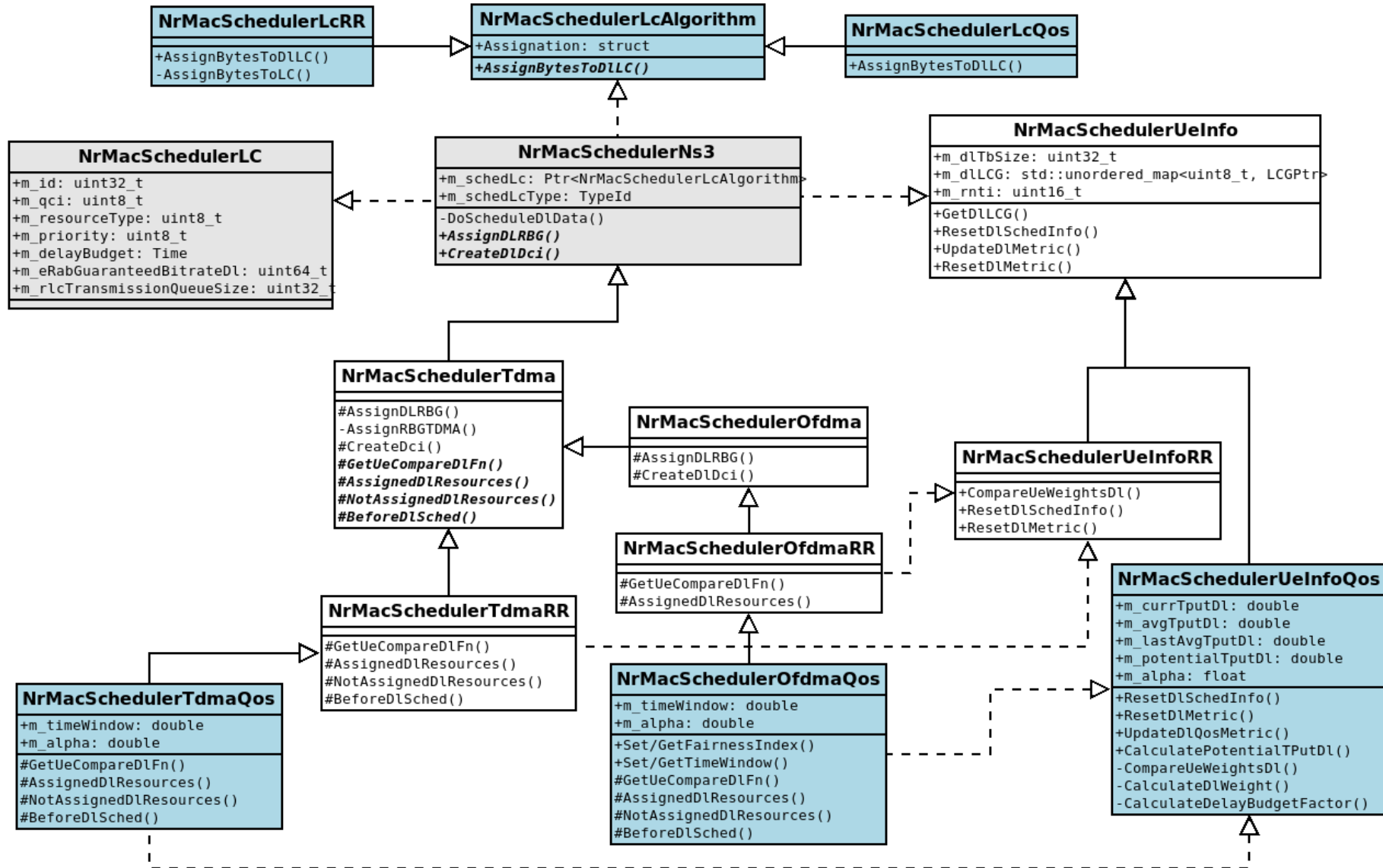

NS-3 IMPLEMENTATION QOS MAC SCHEDULER

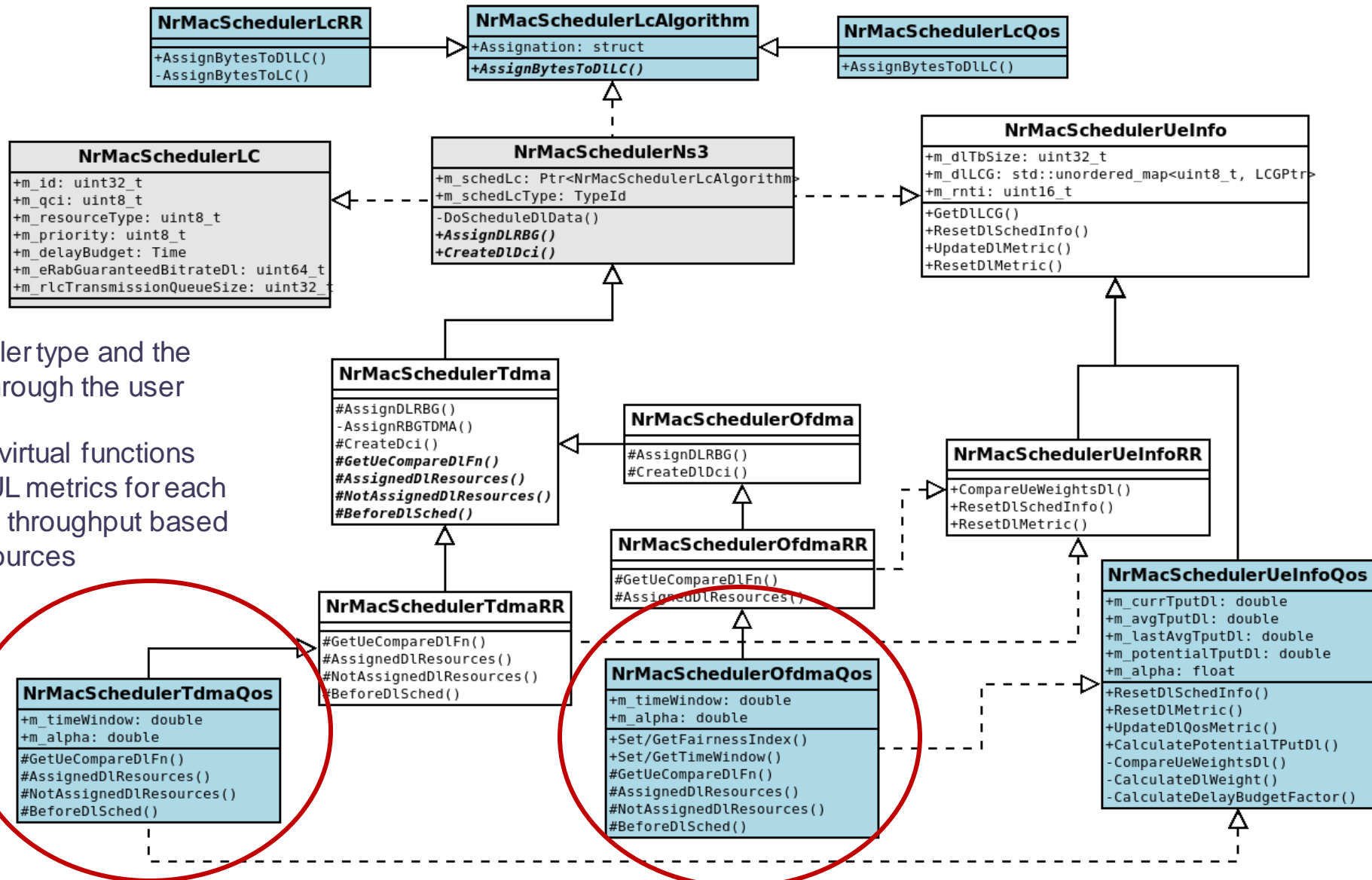

- They set the scheduler type and the access mode type through the user example
- They implement the virtual functions that update the DL/UL metrics for each UE and the potential throughput based on the available resources

NS-3 IMPLEMENTATION QOS MAC SCHEDULER

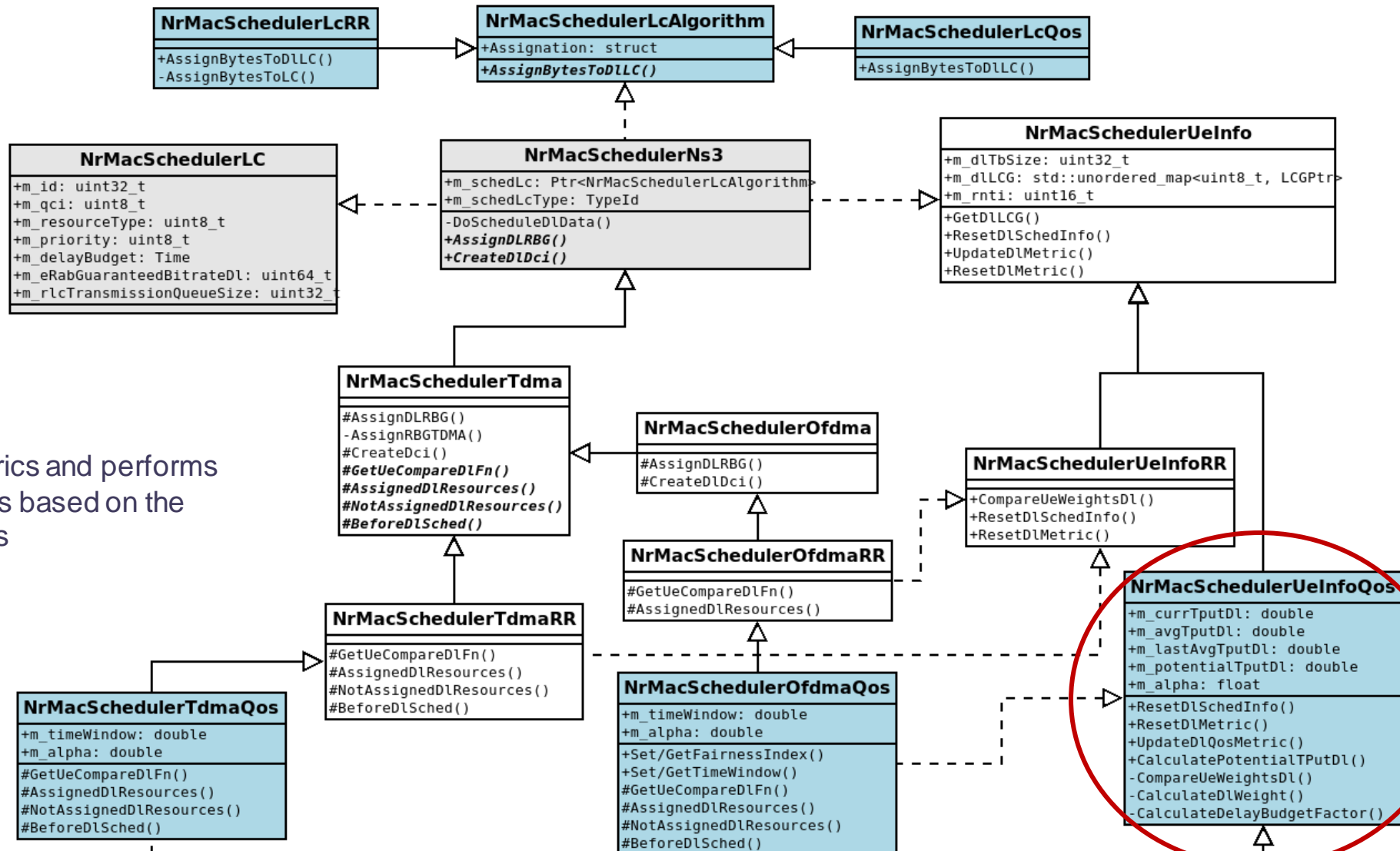

- Uses the DL/UL metrics and performs the sorting of the UEs based on the calculation of weights

NS-3 IMPLEMENTATION QOS MAC SCHEDULER

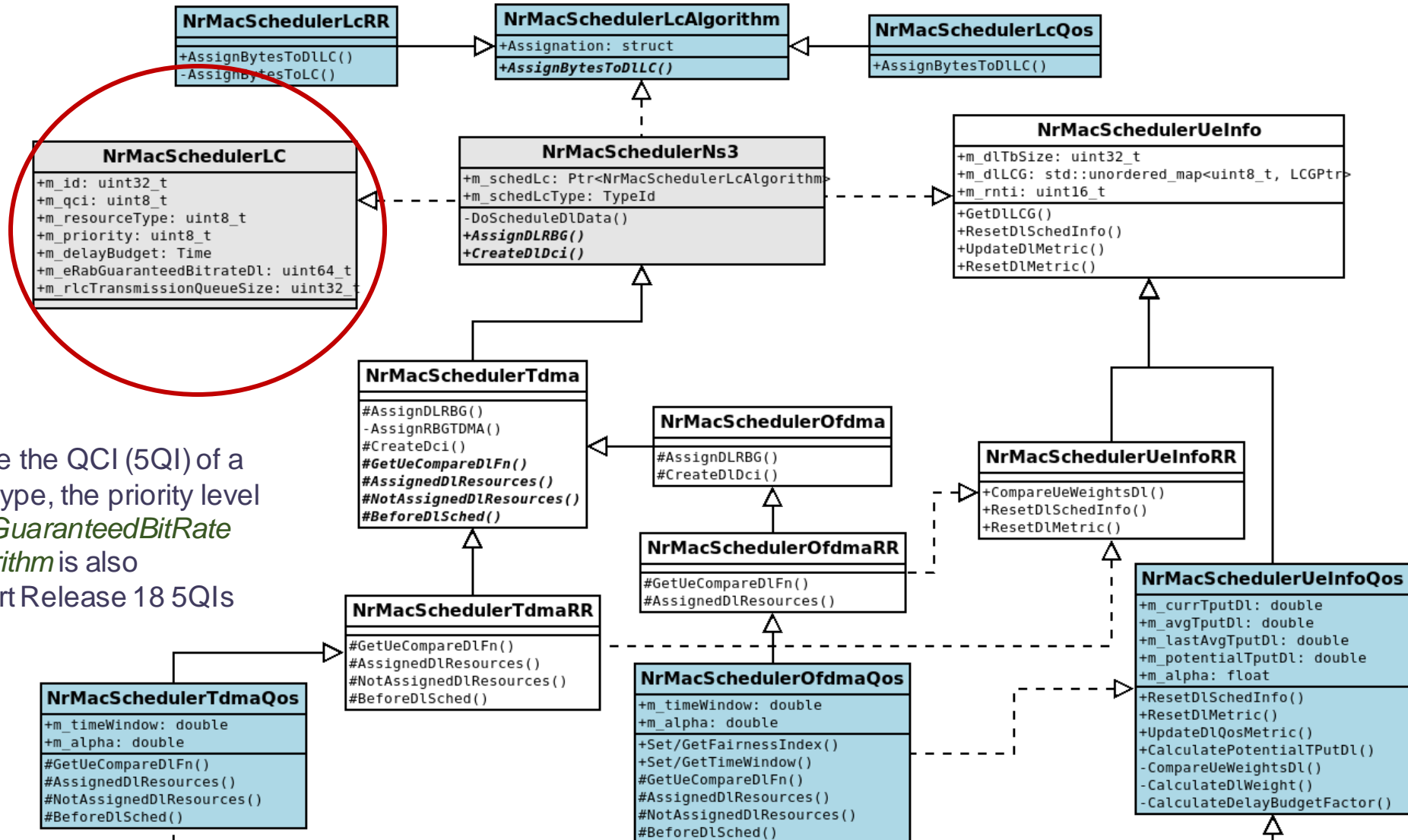

- Extended to include the QCI (5QI) of a flow, the resource type, the priority level (P) and the *e_rabGuaranteedBitRate*
- BwpManagerAlgorithm* is also extended to support Release 18 5QIs

NS-3 IMPLEMENTATION QOS LC ASSIGNMENT

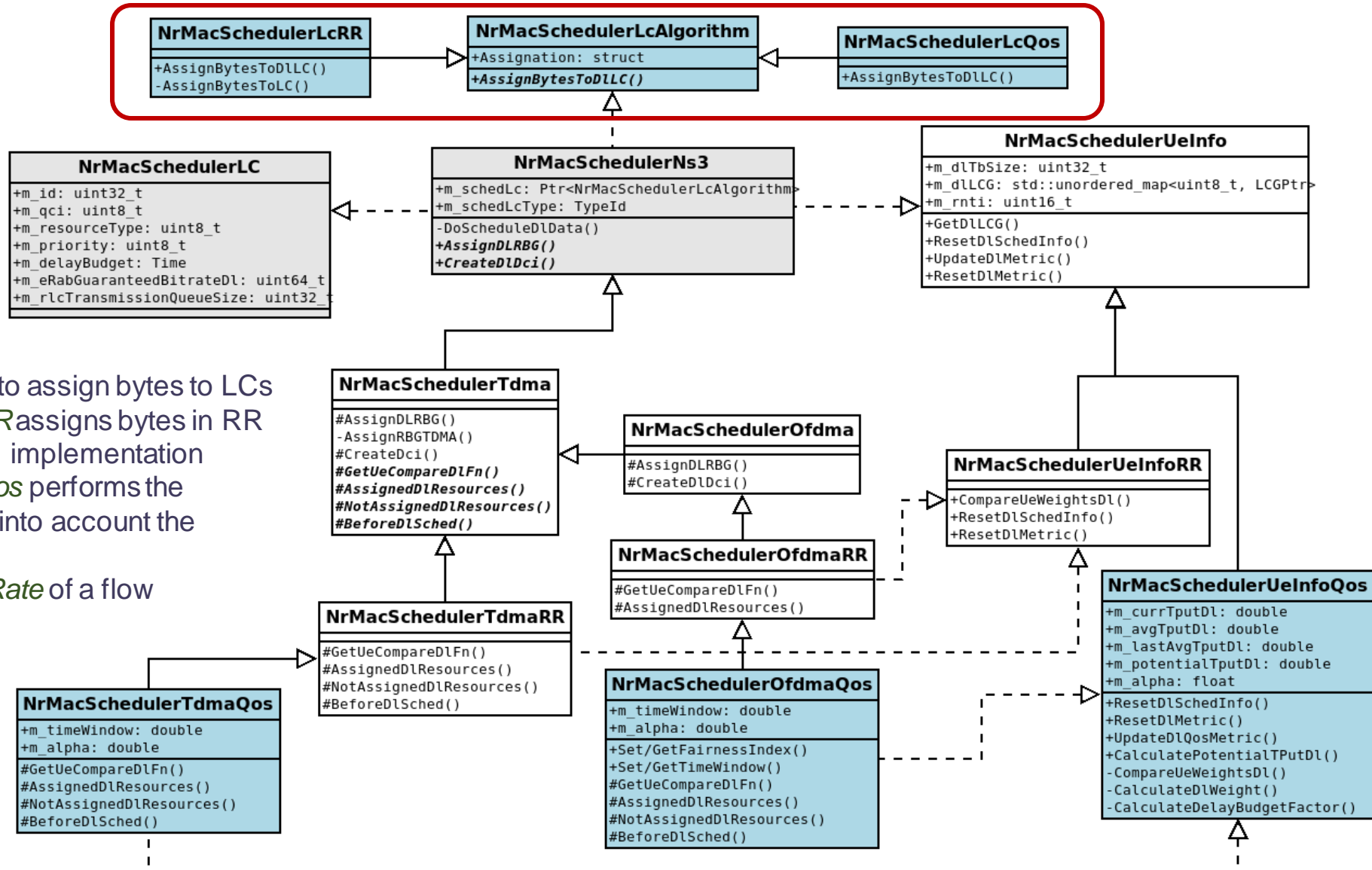

- Created new classes to assign bytes to LCs
- NrMacSchedulerLcRR* assigns bytes in RR fashion as in the initial implementation
- NrMacSchedulerLcQos* performs the assignment by taking into account the resource type and the *e_rabGuaranteedBitRate* of a flow

NS-3 IMPLEMENTATION EXTENSIONS

- Support of DC-GBR in lte module
 - Member *QosBearerType_e* of structure *LogicalChannelConfigListElement_s* is modified to support DC-GBR resource type
 - The logic of how the resource type of a flow is considered in the *EpsBearer* class has been changed
 - Various classes using the old logic have been updated
- Support for Release 18 5QIs
 - *EpsBearer* class has been further extended to support new 5QIs as defined in Release 18
 - *BwpManagerAlgorithm* has been also extended to support these 5QIs

5QI Value	Resource Type	Default Priority Level	Packet Delay Budget (NOTE 3)	Packet Error Rate	Default Maximum Data Burst Volume (NOTE 2)	Default Averaging Window	Example Services
71	GBR	56	150 ms (NOTE 11, NOTE 13, NOTE 15)	10 ⁻⁶	N/A	2000 ms	"Live" Uplink Streaming (e.g. TS 26.238 [76])
72		56	300 ms (NOTE 11, NOTE 13, NOTE 15)	10 ⁻⁴	N/A	2000 ms	"Live" Uplink Streaming (e.g. TS 26.238 [76])
73		56	300 ms (NOTE 11, NOTE 13, NOTE 15)	10 ⁻⁸	N/A	2000 ms	"Live" Uplink Streaming (e.g. TS 26.238 [76])
74		56	500 ms (NOTE 11, NOTE 15)	10 ⁻⁸	N/A	2000 ms	"Live" Uplink Streaming (e.g. TS 26.238 [76])
76		56	500 ms (NOTE 11, NOTE 13, NOTE 15)	10 ⁻⁴	N/A	2000 ms	"Live" Uplink Streaming (e.g. TS 26.238 [76])
87		Delay-critical GBR	25	5 ms (NOTE 4)	10 ⁻³	500 bytes	2000 ms
88	25		10 ms (NOTE 4)	10 ⁻³	1125 bytes	2000 ms	Interactive Service - Motion tracking data, (see TS 22.261 [2])
89	25		15 ms (NOTE 4)	10 ⁻⁴	17000 bytes	2000 ms	Visual content for cloud/edge/split rendering (see TS 22.261 [2])
90	25		20 ms (NOTE 4)	10 ⁻⁴	63000 bytes	2000 ms	Visual content for cloud/edge/split rendering (see TS 22.261 [2])

NS-3 IMPLEMENTATION EXTENSIONS

- Support for PDCP Discard Timer

- *LteRlcUm* has been extended to support the discarding of a packet when the PDCP packet data unit (PDU) is passed from PDCP->RLC
- the value of the discard timer is either an attribute set in the user script, or the PDB value of the flow is used (5QI)
- if the buffering time reaches the discard timer value, the packet will be discarded

- System Test

- *system-scheduler-test-qos* has been implemented to test the correct functionality of the scheduler
- It checks if the obtained throughput is as expected for the QoS scheduling logic

- Validation and Evaluation Example

- *cttc-nr-multiflow-qos-sched.cc*
- single-cell topology with 2 UEs
- UE 1 generates DL non-GBR traffic with 5QI = 80
- UE 2 generates two-flows in DL
 - non-GBR with 5QI = 80
 - DC-GBR with 5QI = 87 and `e_rabGuaranteedBitRate = 5Mbps`

Scenario Parameter	Value
Carrier frequency	4 GHz
Bandwidth	5 MHz / 10 MHz / 50 MHz
Numerology	1
BS/UE transmit power	43/23 dBm
BS/UE antenna height	10/1.5 m
Propagation model	3GPP UMa TR 38.901
BS antenna array	1 TXRU: 1x1 (3GPP elements)
UE antenna array	1 TXRU: 1x1 (isotropic element)
Shadowing/Fading	Disabled/Disabled
Channel condition	LoS, No updates
PDCP Discarding Timer	10ms for 5QI=80 (non-GBR), 5ms for 5QI=87 (DC-GBR) [2]
e_rabGuaranteedBitRate (DC-GBR)	5 Mbps

EVALUATION APPROACH

- We evaluate the QoS MAC scheduler in conjunction with the implemented QoS LC Assignment
- We study two network conditions
 - Non-Saturation: the resources are sufficient to serve all the generated traffic (50 MHz)
 - Saturation: resources are not sufficient to serve all the generated traffic (10 MHz, 5 MHz)
 - The target behind this choice is to provide information related to the average end-to-end delay and throughput, including the user prioritization
- Benchmarks:
 - QoS-RR: QoS MAC scheduler with original LC Assignment method (RR fashion)
 - Proportional Fair (PF) scheduler
 - Round Robin (RR) scheduler

SIMULATION RESULTS

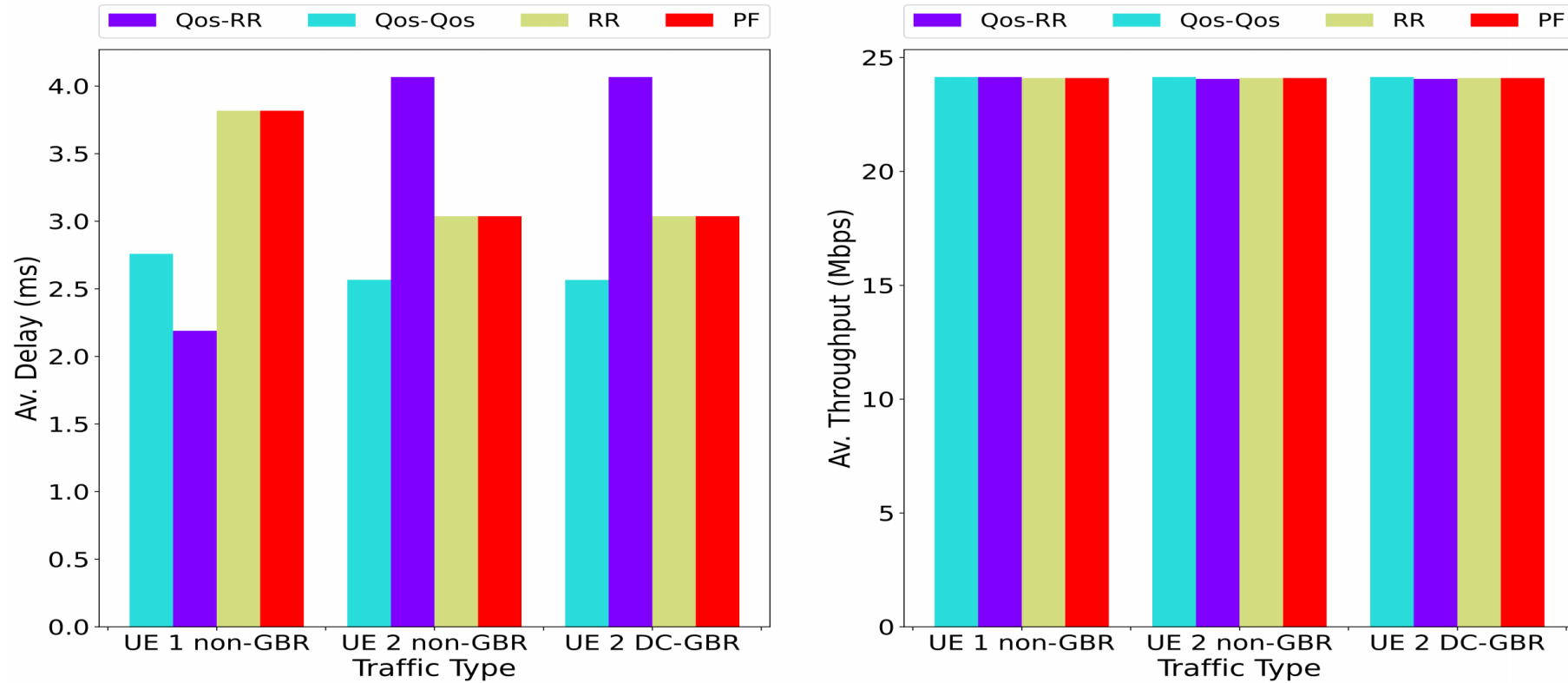

Figure 2: End-to-end Average Delay and Throughput for 50MHz bandwidth

SIMULATION RESULTS

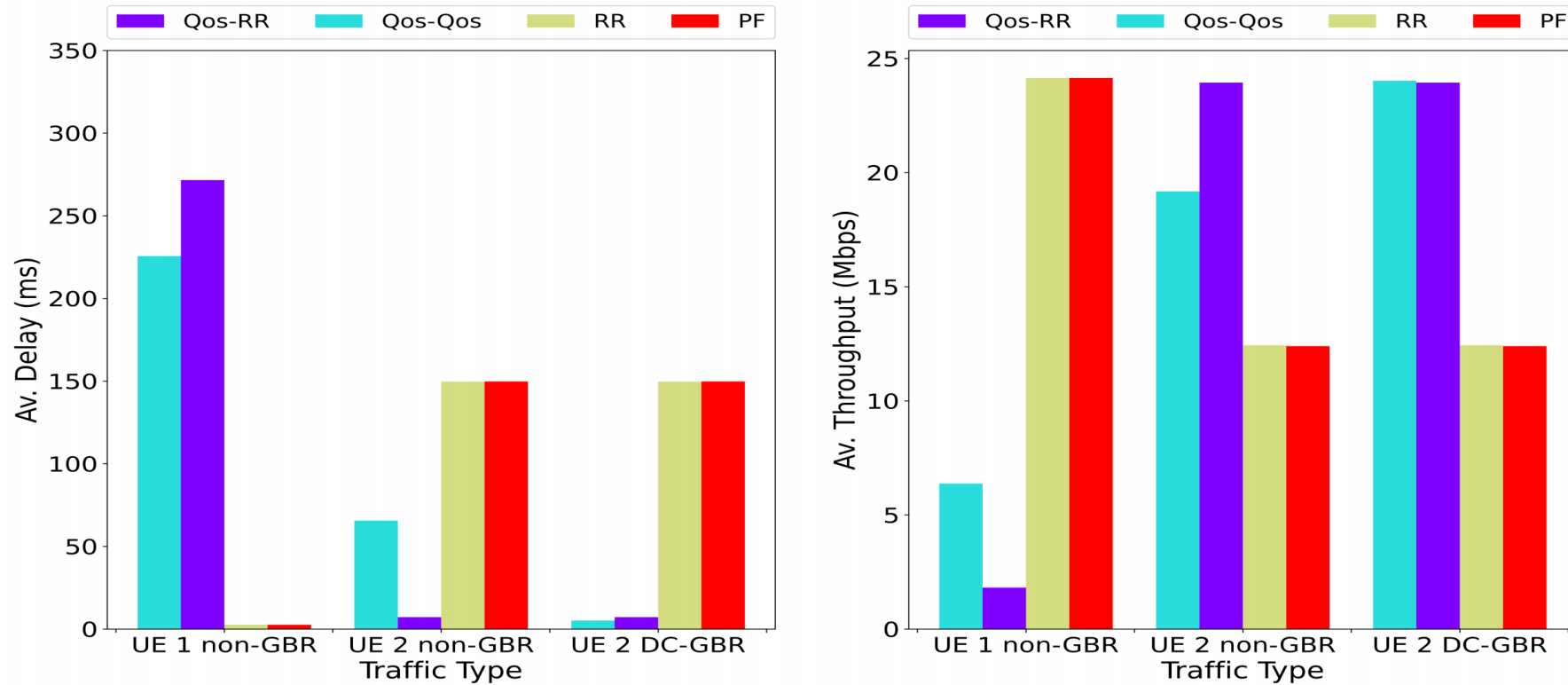

Figure 3: End-to-end Average Delay and Throughput for 10MHz bandwidth

SIMULATION RESULTS

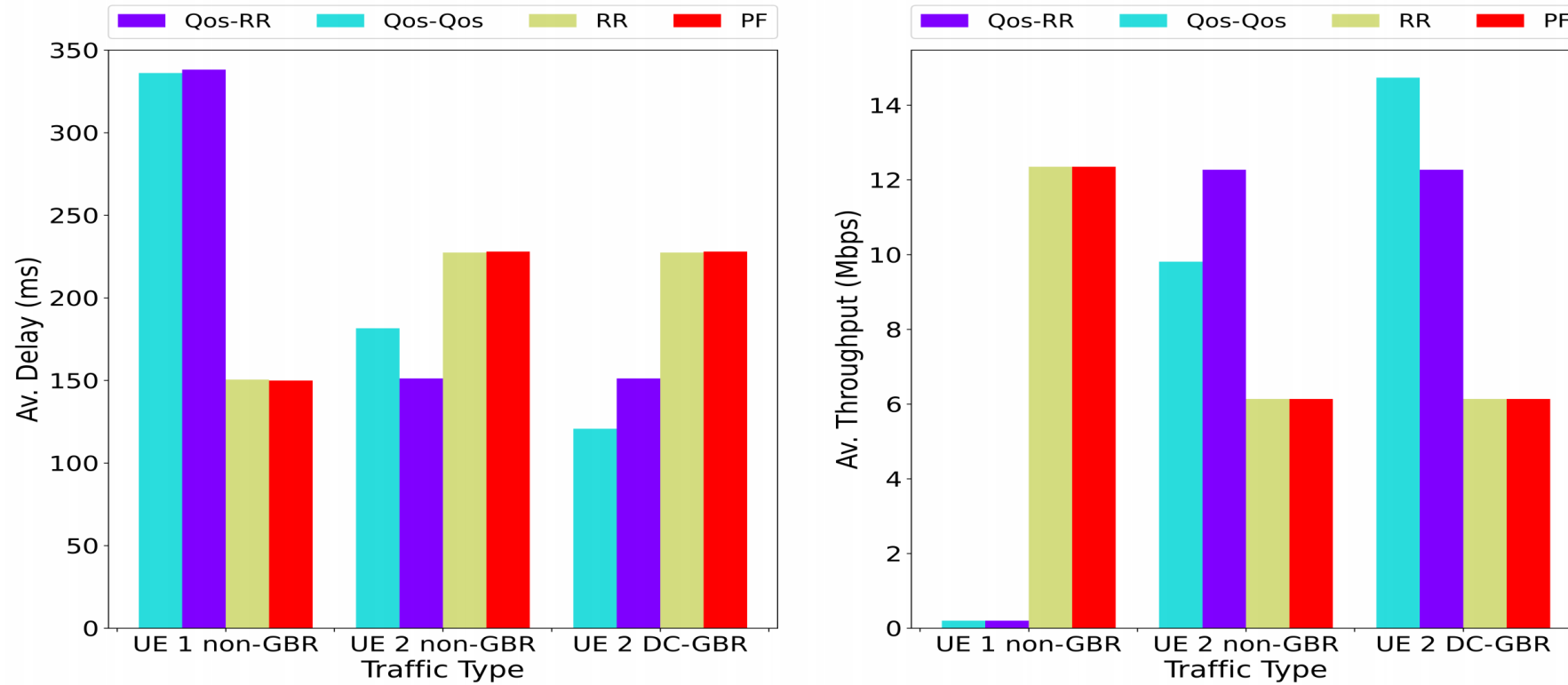

Figure 4: End-to-end Average Delay and Throughput for 5MHz bandwidth



Advanced research for everyday life



HR EXCELLENCE IN RESEARCH